

Swing Module

Swing Module™

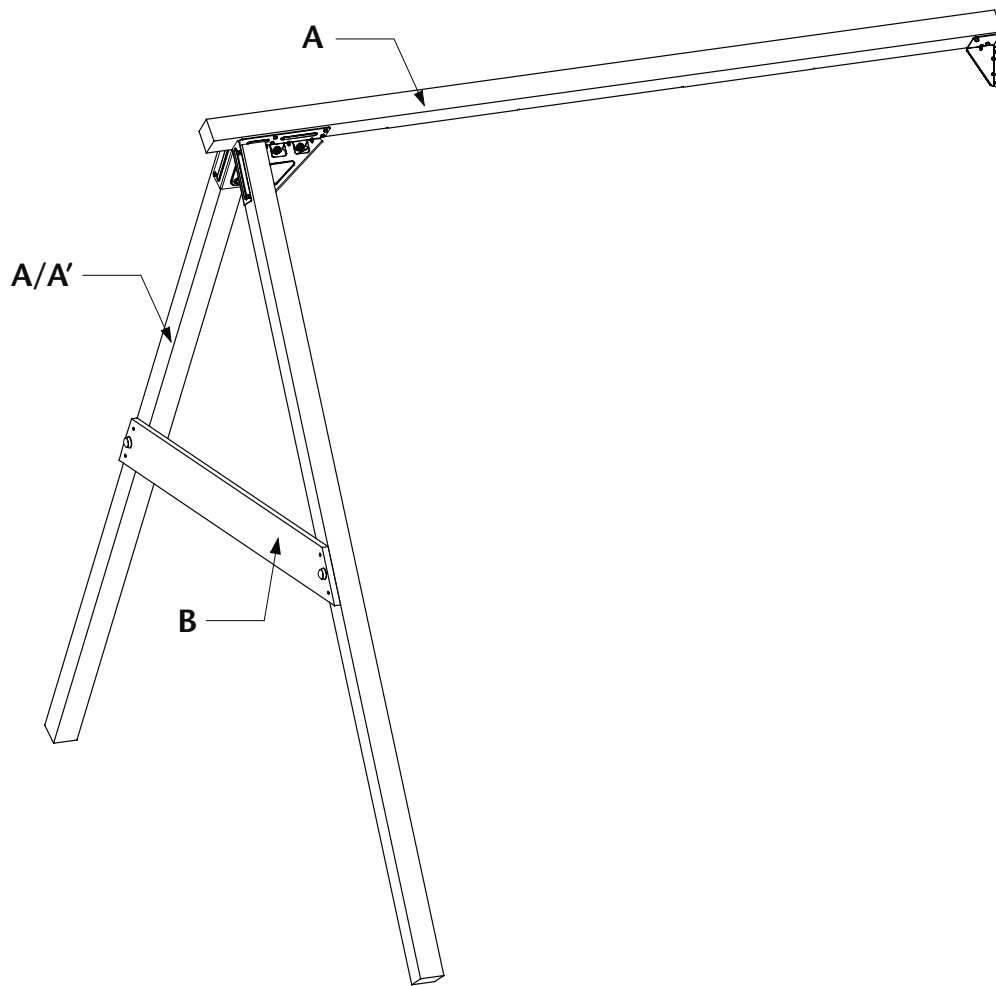

CE
EN 71-1 71-8

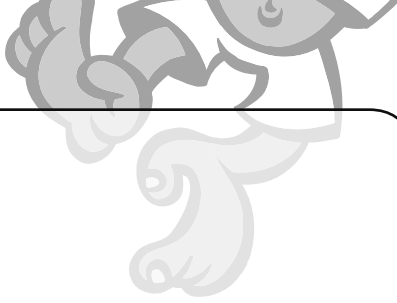

Swing Module

a

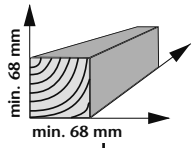

3x **A = 240 cm**

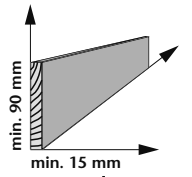

1x **B = 145 cm**

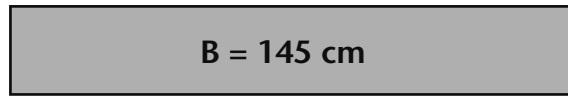

b

Swing Module + # 401.200 Jungle Tower

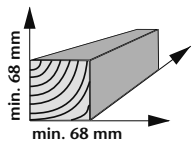

2x **A' = 210 cm**



1x **A = 240 cm**

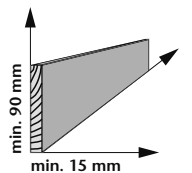

1x **B = 145 cm**

